

General Aptitude (GA)

Q.1 – Q.5 Carry ONE mark Each

Q.1 If '→' denotes increasing order of intensity, then the meaning of the words [drizzle → rain → downpour] is analogous to [_____ → quarrel → feud]. Which one of the given options is appropriate to fill the blank?

- (A) bicker
- (B) bog
- (C) dither
- (D) dodge

GATE 2024

Q.2 Statements:

1. All heroes are winners.
2. All winners are lucky people.

Inferences:

- I. All lucky people are heroes.
- II. Some lucky people are heroes.
- III. Some winners are heroes.

Which of the above inferences can be logically deduced from statements 1 and 2?

- (A) Only I and II
- (B) Only II and III
- (C) Only I and III
- (D) Only III

Q.3 A student was supposed to **multiply** a positive real number p with another positive real number q . Instead, the student **divided** p by q . If the percentage error in the student's answer is 80%, the value of q is

- (A) 5
- (B) $\sqrt{2}$
- (C) 2
- (D) $\sqrt{5}$

Q.4 If the sum of the first 20 consecutive positive odd numbers is divided by 20^2 , the result is

- (A) 1
- (B) 20
- (C) 2
- (D) $1/2$

Q.5 The ratio of the number of girls to boys in class VIII is the same as the ratio of the number of boys to girls in class IX. The total number of students (boys and girls) in classes VIII and IX is 450 and 360, respectively. If the number of girls in classes VIII and IX is the same, then the number of girls in each class is

- (A) 150
- (B) 200
- (C) 250
- (D) 175

GATE 2024

Q.6 – Q.10 Carry TWO marks Each

Q.6 In the given text, the blanks are numbered (i)–(iv). Select the best match for all the blanks.

Yoko Roi stands _____ (i) _____ as an author for standing _____ (ii) _____ as an honorary fellow, after she stood _____ (iii) _____ her writings that stand _____ (iv) _____ the freedom of speech.

- (A) (i) out (ii) down (iii) in (iv) for
- (B) (i) down (ii) out (iii) by (iv) in
- (C) (i) down (ii) out (iii) for (iv) in
- (D) (i) out (ii) down (iii) by (iv) for

- Q.7 Seven identical cylindrical chalk-sticks are fitted tightly in a cylindrical container. The figure below shows the arrangement of the chalk-sticks inside the cylinder.

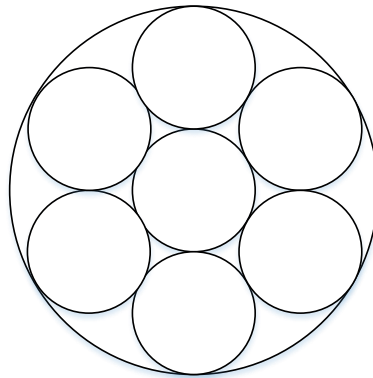

The length of the container is equal to the length of the chalk-sticks. The ratio of the occupied space to the empty space of the container is

- (A) $5/2$
(B) $7/2$
(C) $9/2$
(D) 3

Q.8 The plot below shows the relationship between the mortality risk of cardiovascular disease and the number of steps a person walks per day. Based on the data, which one of the following options is true?

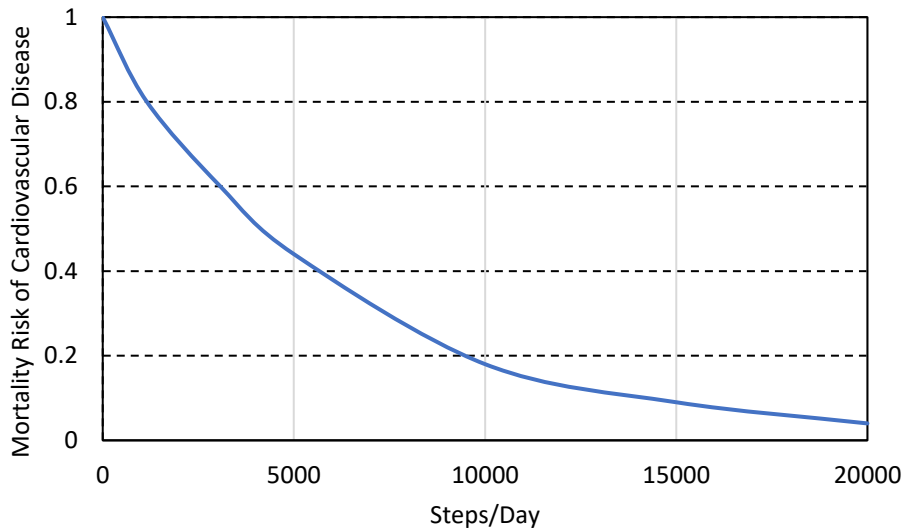

- (A) The risk reduction on increasing the steps/day from 0 to 10000 is less than the risk reduction on increasing the steps/day from 10000 to 20000.
- (B) The risk reduction on increasing the steps/day from 0 to 5000 is less than the risk reduction on increasing the steps/day from 15000 to 20000.
- (C) For any 5000 increment in steps/day the largest risk reduction occurs on going from 0 to 5000.
- (D) For any 5000 increment in steps/day the largest risk reduction occurs on going from 15000 to 20000.

Q.9 Five cubes of identical size and another smaller cube are assembled as shown in Figure A. If viewed from direction X, the planar image of the assembly appears as Figure B.

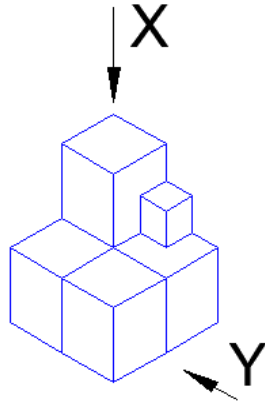

Figure A

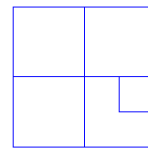
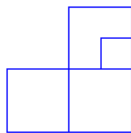

Figure B

If viewed from direction Y, the planar image of the assembly (Figure A) will appear as

(A)



(B)

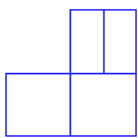

(C)

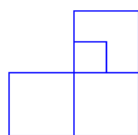

(D)

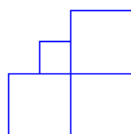

Q.10 Visualize a cube that is held with one of the four body diagonals aligned to the vertical axis. Rotate the cube about this axis such that its view remains unchanged. The magnitude of the minimum angle of rotation is

- (A) 120°
- (B) 60°
- (C) 90°
- (D) 180°

GATE 2024

Q.11 – Q.35 Carry ONE mark Each

Q.11 Exposure to loud impulsive noise may lead to

- (A) Nystagmus
- (B) Siderosis
- (C) Tinnitus
- (D) Stannosis

Q.12 In a self-contained closed-circuit breathing apparatus,

- (A) the exhaled air is released outside the apparatus.
- (B) the exhaled air is wholly absorbed within the apparatus.
- (C) CO₂ is released outside the apparatus after separating from exhaled air.
- (D) CO₂ from exhaled air is absorbed with a chemical.

Q.13 A rectangular mine airway of 2.0 m width and 2.5 m height has a bend with deflection of $\pi/4$ radian. If the radius of curvature of the bend is 4.0 m, the shock factor of the bend is (*round off to three decimals*)

- (A) 0.014
- (B) 0.024
- (C) 0.051
- (D) 0.071

Q.14 In an underground coal mine, two fatalities and three serious bodily injuries occurred during the year 2022. The average daily employment is 1100 and annual working days is 300. The severity index as per DGMS guideline for the mine is

- (A) 12.32
- (B) 25.58
- (C) 31.21
- (D) 34.63

Q.15 For a geared engine winding system, the man winding cage is placed at its normal position at pit top of the shaft. As per CMR 2017, the minimum space, in m, between the center of the hole of the detaching hook attached to the rope shackle and detaching belt plate is

- (A) 3.6
- (B) 2.4
- (C) 1.8
- (D) 1.5

Q.16 The value of integral, $I = \int_0^{\pi/4} \cos x \sin^3 x \, dx$ is

- (A) $\frac{1}{64}$
- (B) $\frac{1}{16}$
- (C) $\frac{1}{4}$
- (D) 1

Q.17 The value of $\lim_{x \rightarrow 0} \left(\frac{n \sin 5x}{\sin 3x} \right)$ is

- (A) $2n$
- (B) $3n/5$
- (C) $6n/5$
- (D) $5n/3$

Q.18 The spherical semivariogram model ($\gamma(h)$) is represented by the following expression, where h is the lag distance.

$$\gamma(h) = \begin{cases} C_0, & \text{for } h = 0 \\ C_0 + (C - C_0) \left[1.5 \frac{h}{a} - 0.5 \left(\frac{h}{a} \right)^3 \right], & \text{for } 0 < h \leq a \\ C, & \text{for } h > a \end{cases}$$

The parameters C_0 , C and a are respectively known as

- (A) nugget, range and sill.
- (B) sill, nugget and range.
- (C) sill, range and nugget.
- (D) nugget, sill and range.

Q.19 In a M/M/1 system, the inter-arrival time of dumpers to a shovel follows exponential distribution with a mean arrival rate of 9 dumpers per hour. The service time of the shovel follows exponential distribution with a mean service rate of 12 dumpers per hour. The probability that exactly one dumper is available to the shovel is

- (A) 1/16
- (B) 3/16
- (C) 3/4
- (D) 1/4

Q.20 A project network with the sequence of five activities is shown.

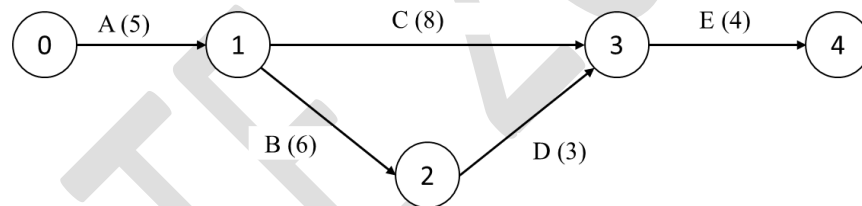



The crashing costs of activities are

| Activity | A | B | C | D | E |
|-----------------------------------|-----|-----|-----|-----|-----|
| Duration (week) | 5 | 6 | 8 | 3 | 4 |
| Crashing cost per week (lakh INR) | 4.0 | 2.5 | 2.0 | 3.0 | 4.0 |

If the project is crashed by one week, the increase in project cost, in lakh INR, is

- (A) 2.0
- (B) 2.5
- (C) 3.0
- (D) 4.0

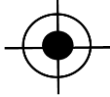
Q.21 Match the following features with the corresponding symbols

| | Feature in mine plan | | Symbol |
|---|------------------------|---|---|
| P | Shaft | 1 |  |
| Q | Staple shaft | 2 |  |
| R | Abandoned shaft | 3 |  |
| S | Abandoned staple shaft | 4 |  |

- (A) P → 1; Q → 3; R → 4; S → 2
- (B) P → 4; Q → 2; R → 1; S → 3
- (C) P → 2; Q → 4; R → 3; S → 1
- (D) P → 4; Q → 1; R → 2; S → 3

Q.22 If the major (σ_1) and minor (σ_3) principal stresses for a rock element have a relationship as $\sigma_3 = -\frac{1}{2}\sigma_1$, the maximum shear stress is expressed by

- (A) $\frac{4}{3}\sigma_1$
- (B) $\frac{3}{4}\sigma_1$
- (C) $\frac{1}{2}\sigma_1$
- (D) $\frac{1}{4}\sigma_1$

Q.23 The ore that is NOT used for commercial extraction of metal is

- (A) Wolframite.
- (B) Dolomite.
- (C) Cassiterite.
- (D) Uraninite.

Q.24 The function of District Mineral Foundation established by state governments in India, is to

- (A) look after safety aspects of mining operations.
- (B) approve mining plan.
- (C) act as an environmental regulatory body.
- (D) monitor welfare of mining affected people.

Q.25 The percentage Fe and corresponding net value for an iron ore mine is given below

| Fe (%) | Net value (INR per tonne) |
|--------|---------------------------|
| 58 | 4000 |
| 62 | 4500 |

Assuming net value *versus* grade curve to be a straight line, and mining cost of waste is INR 1000 /m³; the correct representation of stripping ratio, SR (m³/tonne) *versus* Fe (%) grade curve is

- (A) $SR = -3.250 + 0.125 \times Fe$
- (B) $SR = 3.250 + 0.125 \times Fe$
- (C) $SR = 3250 + 125 \times Fe$
- (D) $SR = -3250 + 125 \times Fe$

Q.26 The magnitude of the curl of the vector $\mathbf{F} = 2x\mathbf{i} + 3y\mathbf{j} + 4z\mathbf{k}$, is

- (A) 0
- (B) 4
- (C) 9
- (D) 25

Q.27 An explosive with a density of 1.2 g/cm³ has a heat of explosion equal to 900 cal/g. If the heat of explosion of ANFO with density of 0.8 g/cm³ is 950 cal/g, the bulk strength of the explosive relative to ANFO is _____. (round off up to 2 decimals)

- Q.28 A typical 24-hour activity of a mobile crusher plant is shown. The utilization, in %, of the plant, is _____. (round off up to 2 decimals)

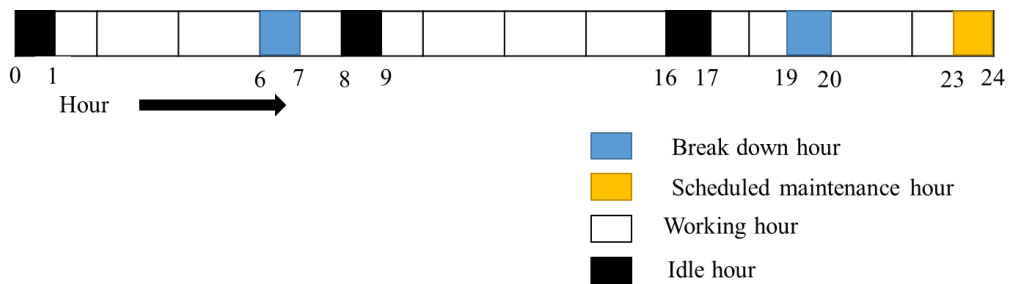

- Q.29 A coal washery discharges $300 \text{ m}^3/\text{day}$ of contaminated water in a stream having a flow rate of $0.04 \text{ m}^3/\text{s}$. The DO level of the stream and the contaminated water are 8.5 mg/L and 4 mg/L , respectively. Neglecting the impact of temperature, the resultant DO, in mg/L , of the stream just after mixing is _____. (round off up to 2 decimals)
- Q.30 The combined sound pressure level measured at a point in a production bench due to one dumper and one shovel is 95 dB(A) . If the sound pressure level of shovel alone is 90 dB(A) , the sound pressure level of the dumper alone, in dB(A) , at the same point is _____, (round off up to 2 decimals)
- Q.31 The void ratio of an unconsolidated soil heap of volume 1000 m^3 is 1.0 . If the soil heap is consolidated to a volume of 800 m^3 , the corresponding void ratio is _____. (round off up to 2 decimals)
- Q.32 For a circular path of radius 300 m , the super elevation is restricted to 0.1 m for a width of 1.6 m . The maximum speed, in m/s , of vehicle to avoid overturn is _____. (round off up to 2 decimals)

Q.33 A scanline survey between points A and B of a rock mass is shown. Consider

$$RQD = 100 \times (0.1\lambda + 1) \times \exp(-0.1\lambda),$$

where, λ is the frequency of discontinuity per m. The RQD of the rock mass is _____. (round off up to 2 decimals)

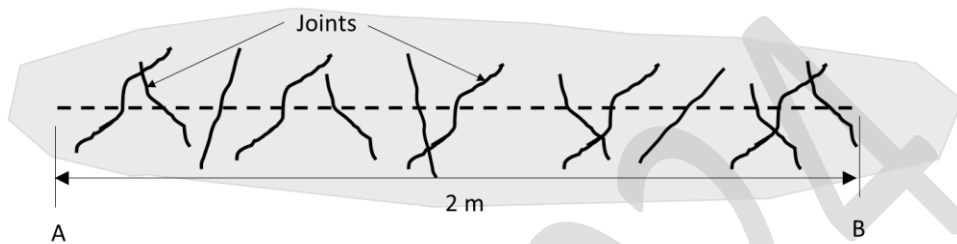

Q.34 In a VCR stope, blast holes of 165 mm diameter are drilled. For the blast hole to behave as a spherical charge, the maximum charge length, in m, is _____. (round off up to 2 decimals)

Q.35 A rectangular development heading of dimension 3 m × 2.8 m is to be blasted with holes of 2.4 m in length. If the pull factor is 0.95 and swell factor is 1.20, the volume of blasted rock per round, in m³, is _____. (round off up to 2 decimals)

Q.36 – Q.65 Carry TWO marks Each

Q.36 Data from two production faces of an open pit iron ore mine are given.

| Item description | Face 1 | Face 2 |
|---|--------|--------|
| Maximum production capacity (tonne/day) | 1600 | 2000 |
| Fe (%) | 63 | 58 |
| Production cost of ores (in INR/tonne) | 1500 | 1200 |

Ores from two different faces are blended and supplied with Fe grade not less than 60 %. Based on the demand, the combined production is limited to a maximum of 2500 tonne/day. If the selling price of blended iron ores is INR 4500 /tonne, the optimal production from two faces in tonne/day, for maximizing the profit, respectively are

- (A) 1000.0 and 1500.0
- (B) 1333.3 and 1166.7
- (C) 1600.0 and 900.0
- (D) 500.0 and 2000.0

Q.37 Four identical districts of a mine are ventilated with a quantity of 3500 m³/min at a fan drift pressure of 1.15 kPa. When one of the districts is sealed off, the change in resultant resistance is 0.072 N s² m⁻⁸. If the fan is stopped, keeping a district sealed, the quantity through the mine becomes 850 m³/min. The natural ventilation pressure in Pa, is

- (A) 72.12
- (B) 82.28
- (C) 105.56
- (D) 144.56

Q.38 Matrix $\mathbf{A} = \begin{bmatrix} 1 & 4 & 3 \\ 5 & 2 & 1 \\ 6 & 4 & 3 \end{bmatrix}$, and $\mathbf{B} = \mathbf{A} - \mathbf{A}^T$, then \mathbf{B} is

- (A) symmetric.
- (B) skew symmetric.
- (C) diagonal.
- (D) scalar.

Q.39 The roof convergence data for 30 days at a monitoring station in a coal mine gallery is given.

| Day | Convergence reading (mm) |
|-----|--------------------------|
| 0 | 0 |
| 5 | 4.7 |
| 10 | 11.3 |
| 16 | 19.6 |
| 22 | 28.8 |
| 30 | 34.8 |

The management decides on a Trigger Action Response Plan (TARP) if the following two premises occur simultaneously.

Premise 1: Rate of convergence exceeds 1.5 mm/day between two consecutive measurements.

Premise 2: Rate of cumulative increase in convergence exceeds 1.0 mm/day.

Identify the day on which TARP is enforced in that gallery.

- (A) 10
- (B) 16
- (C) 22
- (D) 30

Q.40 Magnitude of error in the determination of the integral, I using Simpson's 1/3 rule, taking step length as 1.0 is

$$I = \int_1^3 (x^3 + 6)dx$$

- (A) 0
- (B) 1.0
- (C) 1.5
- (D) 2.0

Q.41 In a closed traverse, ABC, the bearings of two lines AB and BC are given.

| Line | Length (m) | Bearing |
|------|------------|---------|
| AB | 100 | 90° |
| BC | 120 | 150° |

The length, in m and bearing of line CA, in degree, respectively, are

- (A) 190.7 and 303°
- (B) 190.7 and 240°
- (C) 160.3 and 240°
- (D) 160.3 and 303°

Q.42 Match the method of mining with orebody geometry, orebody strength and type of supports.

| Geometry | Strength | Support | Method |
|-------------------------------|-------------|---------------------------|--------------------|
| P. Tabular & Moderately Steep | L. Strong | X. Unsupported | 1. Cut and Fill |
| Q. Tabular & Flat | M. Moderate | Y. Artificially Supported | 2. Block Caving |
| R. Massive and Steep | N. Weak | Z. Self-supported | 3. Room and Pillar |

- (A) $P \rightarrow L \rightarrow Y \rightarrow 3; Q \rightarrow N \rightarrow Z \rightarrow 1; R \rightarrow M \rightarrow X \rightarrow 2$
- (B) $P \rightarrow M \rightarrow Y \rightarrow 2; Q \rightarrow N \rightarrow Z \rightarrow 1; R \rightarrow L \rightarrow X \rightarrow 3$
- (C) $P \rightarrow L \rightarrow Y \rightarrow 2; Q \rightarrow M \rightarrow Z \rightarrow 3; R \rightarrow N \rightarrow X \rightarrow 1$
- (D) $P \rightarrow M \rightarrow Y \rightarrow 1; Q \rightarrow L \rightarrow Z \rightarrow 3; R \rightarrow N \rightarrow X \rightarrow 2$

Q.43 Vectors $\mathbf{a} = 2\mathbf{i} + 3\mathbf{j} - 4\mathbf{k}$ and $\mathbf{b} = 4\mathbf{i} + 2\mathbf{j} + 3\mathbf{k}$ represent the two adjacent sides of a triangle. The magnitude of the area of the triangle and the unit vector perpendicular to both \mathbf{a} and \mathbf{b} respectively, are

- (A) 28.93 and $0.58\mathbf{i} - 0.76\mathbf{j} - 0.27\mathbf{k}$
- (B) 28.93 and $17.0\mathbf{i} - 22.0\mathbf{j} - 8.0\mathbf{k}$
- (C) 14.46 and $0.58\mathbf{i} - 0.76\mathbf{j} - 0.27\mathbf{k}$
- (D) 14.46 and $17.0\mathbf{i} - 22.0\mathbf{j} - 8.0\mathbf{k}$

- Q.44 Water is pumped from a mine sump at the rate of $300 \text{ m}^3/\text{hr}$ to an inverted conical water tank, as shown. The rate of rise in water level in m/min , at the instant water level reaches at 5 m height from bottom of the tank, is _____. (round off up to 2 decimals)

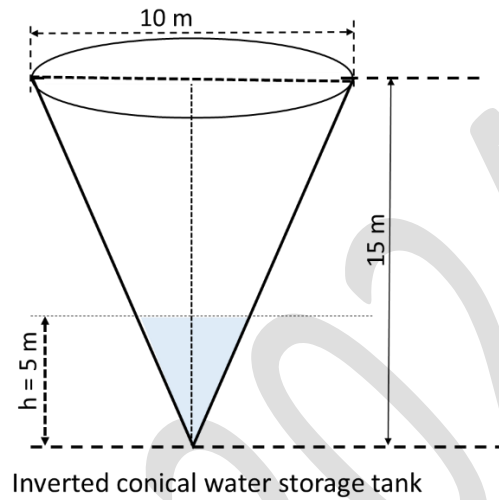

- Q.45 A thermal power plant has an agreement with three mines M1, M2 and M3 to receive 'Grade 1' coal, in the proportion of 60%, 25% and 15%, respectively. The probabilities that a wagon supplied coal to the plant containing below 'Grade 1' from mines M1, M2 and M3 are 0.02, 0.03 and 0.04, respectively. On a random check, a sample wagon is found to carry below 'Grade 1' coal. The probability that the wagon belongs to mine M1, is _____. (round off up to 2 decimals)

Q.46 A transportation system for carrying ore from stock pile to railway siding through an ore bin is shown. The time between failure of each conveyor belt follows an exponential distribution with mean time between failure of 700 hours. The system is considered to be a ‘success’ if ore transports from stock pile to siding by any combination of belts. The reliability of the system for 350 hours of continuous successful operation, is _____. (round off up to 2 decimals)

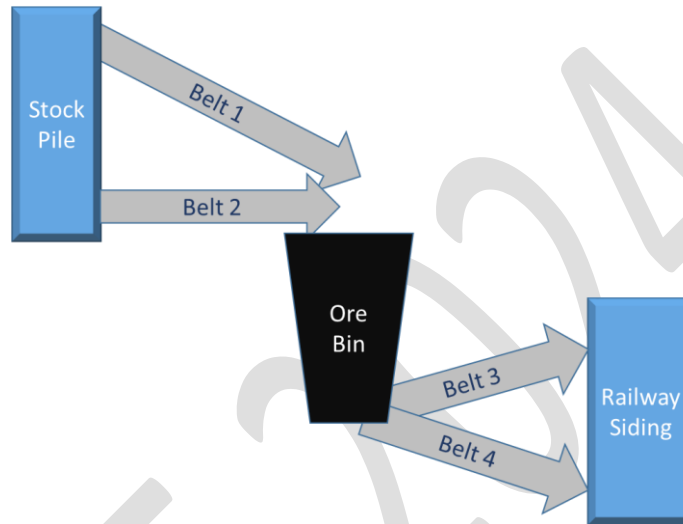

Q.47 Polluted air with particulate matters of diameter $50 \mu\text{m}$ enter with a horizontal velocity of 1.0 m/s at a height of 0.5 m from the bottom of a dry settling chamber. The density of the particle is 2000 kg/m^3 and dynamic viscosity of the air is $1.8 \times 10^{-5} \text{ kg/m-s}$.

Assume streamline flow and the density of air is negligible as compared to particles and uniform horizontal velocity of 1.0 m/s of gas and particles within the chamber.

Considering particle settling follows Stoke’s law, the minimum length in m, of the chamber required for settling of the particle at its bottom, is _____. (round off up to 2 decimals)

Q.48 In a tacheometry survey, the readings observed are given.

| Instrument Station | Staff Station | Bearing of line of sight | Vertical angle | Staff readings (m) |
|--------------------|---------------|--------------------------|----------------|--------------------|
| P | A | 145° | $+8^\circ$ | 1.2, 1.7, 2.2 |
| | B | 205° | $+3^\circ$ | 0.8, 1.2, 1.6 |

The additive and multiplying constants of the instrument are 0 and 100, respectively. The length of the line AB in m, is _____. (round off up to 2 decimals)

Q.49 The data obtained from an air sample analysis of an old working in a coal mine are given.

O₂ 17.15%, CO₂ 3.40%, CH₄ 2.20%, and N₂ 77.25%.

Considering atmospheric air contains

O₂ 20.95%, CO₂ 0.03%, and N₂ 79.02%,

the percentage of blackdamp in the old working, is _____. (round off up to 2 decimals)

Q.50 A rectangular face of 2.0 m x 2.5 m dimension is blasted with 20 kg explosive in a 1000 m long drive. One kilogram of explosive produces 2200 cm³ of nitrous fumes. The face is ventilated with a duct, located 10.0 m away from the face, to dilute the fumes. The quantity of air, in m³/s to be circulated for reducing the concentration of nitrous fumes to 5 ppm within a period of 5 minutes, is _____. (round off up to 2 decimals)

[Use the relation, $t = 2.303 \frac{V_m}{Q} \log \frac{q}{V_m c} + \frac{V - V_m}{Q}$, where t = time, V_m = volume of the tunnel over which the mixing of the gases produced at the face, and air delivered by the fan occurs, c = concentration at time, t , V = volume of tunnel, Q = quantity of air flow, q = total volume of nitrous fumes produced]

Q.51 Data for a centrifugal pump discharging water from a sump to the surface are given.

Head, m : 180

Discharge rate, m³/hr : 320

Operating hours per day for 270 days in a year : 14

Operating hours per day for remaining 95 days : 20

Overall efficiency of the pumping system : 0.70

Specific weight of mine water, kN/m³ : 10.20

The annual electrical power consumption in GWh, due to pumping operation, is _____. (round off up to 2 decimals)

Q.52 The root of the function, $f(x) = x^3 - 2x^2 + 3x - 1$ in the interval $[0, 1]$ using bisection method after two iterations, is _____. (round off up to 2 decimals)

Q.53 A Bord and Pillar panel is developed at a depth of 250 m in a flat coal seam. The vertical stress gradient is 0.027 MPa/m. If the strength of a square pillar is 12.5 MPa, the extraction ratio of the pillar for a safety factor of 1.5, is _____. (round off up to 2 decimals)

Q.54 A Mohr-Coulomb envelop between shear stress, τ and normal stress, σ_n of a sandstone rock is given as

$$\tau = 7.5 + 0.84 \sigma_n \quad (\text{unit of stresses is MPa})$$

A sandstone sample is tested in triaxial mode with confining pressure of 5.0 MPa. The value of the shear stress, τ in MPa at the failure, is _____. (round off up to 2 decimals)

- Q.55 A circular tunnel is constructed at a depth of 100 m. The average unit weight of overburden rock is 27.0 kN/m^3 . If the tangential stress measured at point A located at the horizontal boundary of the tunnel as shown, is 5.0 MPa , the tangential stress at point B in MPa, is _____. (round off up to 2 decimals)

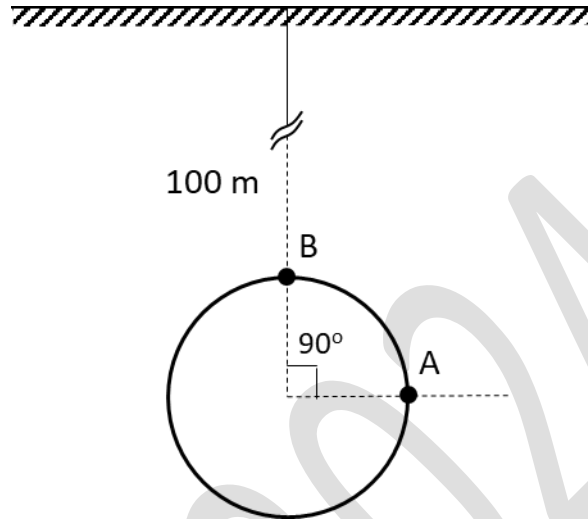

Q.56 A mine worker weighing (W) 600 N lifts an object of 100 N as shown. The 50% body weight is applied downward through point A and a force F_E is produced parallel to x axis by the contraction of erector spinae muscle during lifting. The lumber disc, L (shown by red box) acts as a smooth hinge and keeps the upper body in static equilibrium. Ignore all other forces in the body. The magnitude of the resultant of the reaction forces, in N at the lumber disc, is _____. (round off up to 2 decimals)

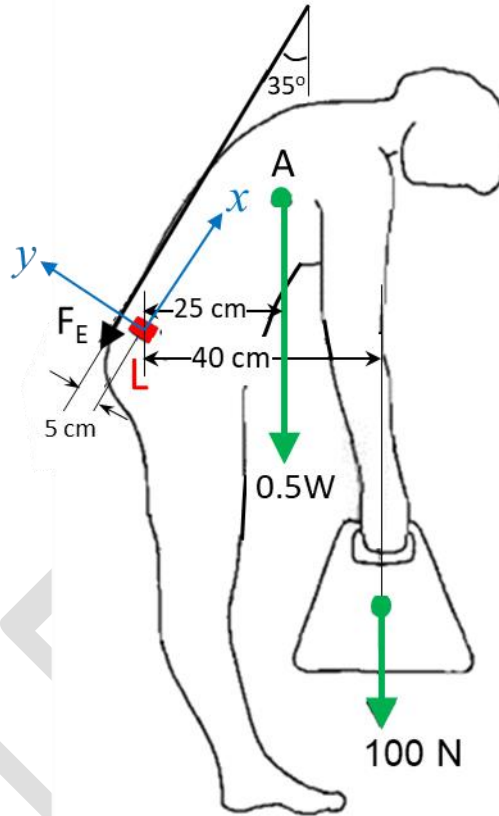

Q.57 A solid ball of mass 10 kg is subjected to forces as shown. The magnitude of the acceleration in m/s^2 , is _____. (round off up to 2 decimals)

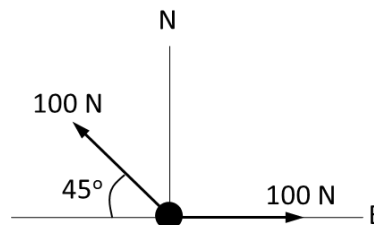

Q.58 In an open pit mine, the mineral inventory, prices, costs and capacities are given.

| Mineral inventory | |
|------------------------------|----------------------------|
| Grade interval | Tonnage (in million tonne) |
| $0 < \text{Cu}\% \leq 0.3$ | 0 |
| $0.3 < \text{Cu}\% \leq 0.4$ | 5 |
| $0.4 < \text{Cu}\% \leq 0.5$ | 5 |
| $0.5 < \text{Cu}\% \leq 0.6$ | 5 |
| $0.6 < \text{Cu}\% \leq 0.7$ | 5 |
| $0.7 < \text{Cu}\% \leq 0.8$ | 5 |
| $0.8 < \text{Cu}\%$ | 0 |

Concentrating cost : INR 3,200/tonne of ore milled
 Smelting & refinery cost : INR 10,000/tonne of copper metal
 Selling price : INR 6,50,000/tonne of copper metal
 Overall recovery : 100%
 Maximum production capacity : 5 million tonne/annum

The mine is operating at 5 million tonne in a year. Considering mining capacity being the only constraint, Lanes' algorithm (based on profit maximization) is used for determining mill cut-off grade. The total amount of copper produced in million tonne, in the life of the pit, is _____. (round off up to 2 decimals)

Q.59 A longitudinal section of a mined out stope block in a copper mine is shown by the shaded portion. For a uniform thickness of the stope block, the percentage of ore recovery, is _____. (round off up to 2 decimals)

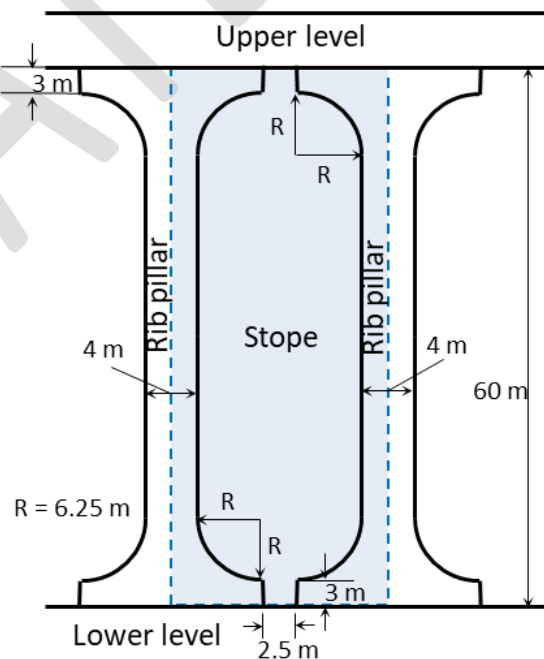

Q.60 The real rate of return from a mining project is 14%. If the inflation rate over the entire life of the mine is 5.5 %, then the nominal rate of return in %, is _____. (round off up to 2 decimals)

Q.61 In an opencast coal mine, blast vibrations are measured at two locations, A and B simultaneously for a maximum charge per delay (Q) of 1200 kg as given.

| Location | Distance from the blast face, D (m) | PPV (mm/s) |
|----------|-------------------------------------|------------|
| A | 100 | 112.5 |
| B | 300 | 20.3 |

Assume the relation

$$PPV = K \left[\frac{D}{\sqrt{Q}} \right]^{-\beta}$$

where, K and β are site constants. The PPV in mm/s, at a distance of 200 m from the blast face, is _____. (round off up to 2 decimals)

Q.62 A 35.0 kW motor transmits power to a pulley of 600 mm diameter, which rotates at 400 rpm to drive a flat belt. The tension in the tight side is 2.5 times of the slack side. Neglect all transmission losses. If the maximum allowable tension is 8.0 N per mm of belt width, then the minimum width of the belt in mm, is _____. (round off up to 2 decimals)

Q.63 A 1.2 m diameter drum winding system is shown. One of the winding ropes will be replaced for the manwinding cage.

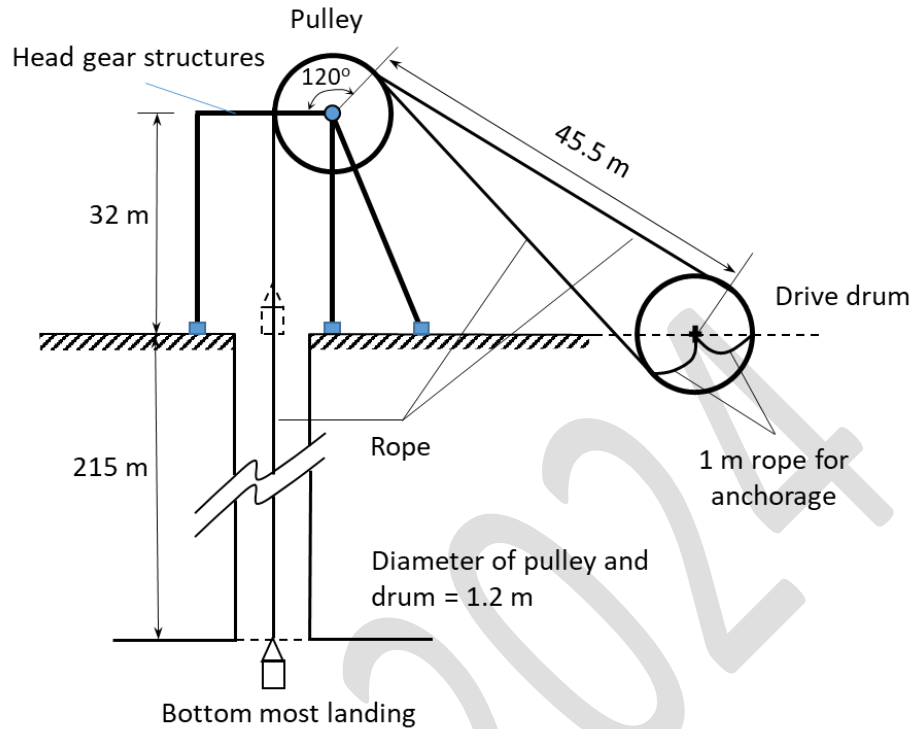

Consider the following:

- 1) A new rope is recapped once at least in every 6 months and a length of 2 m including existing capping is to be cut off from the rope before recapping.
- 2) The maximum life of a rope is 3.5 years and at least 2 rounds of rope should remain on the drum while the descending cage lands at the bottommost landing point.
- 3) No overwinding will take place during the maximum life of the new rope.

Neglecting the impact of fleet angle on the length of the rope, the minimum length, in m, of new winding rope is _____. (round off up to 2 decimals)

Q.64 For a continuous miner (CM) panel, the following data are given.

Data related to CM

Dimension of a working face : 5.0 m (width) x 3.0 m (height)
Web depth, m : 0.6
Time for one web cut up to full height, min : 9

Data related to shuttle car

Bucket capacity of shuttle car, tonne : 10
Fill factor : 0.9
Number of cars : 2
Cycle time of each car including
loading, travel and unloading, min : 6

Assume, unit weight of coal is 1.4 tonne/m^3 and its swell factor is 1.2. Consider, 6 working hours per shift.

The non-working time in min, in working hours per shuttle car to dispatch all coal cut by the CM, is _____. (round off up to 2 decimals)

Q.65 In a development coal face, 12 holes are drilled and charged with explosive. Holes are initiated with electric delay detonators connected in series. The length of a detonator lead wire is 1.5 m. The length of the blasting cable is 120 m.

Data are as given:

Resistance of each detonator : 1.48Ω
Resistance of lead wire : $0.04 \Omega/\text{m}$
Resistance of one wire of the blasting cable : $0.009 \Omega/\text{m}$

The total resistance of the circuit in Ω , is _____. (round off up to 2 decimals)



Mining Engineering (MN) Master Answer Key

| Q. No. | Session | Question Type | Section | Key/Range | Mark |
|--------|---------|---------------|---------|----------------|------|
| 1 | 4 | MCQ | GA | A | 1 |
| 2 | 4 | MCQ | GA | B | 1 |
| 3 | 4 | MCQ | GA | D | 1 |
| 4 | 4 | MCQ | GA | A | 1 |
| 5 | 4 | MCQ | GA | B | 1 |
| 6 | 4 | MCQ | GA | D | 2 |
| 7 | 4 | MCQ | GA | B | 2 |
| 8 | 4 | MCQ | GA | C | 2 |
| 9 | 4 | MCQ | GA | A | 2 |
| 10 | 4 | MCQ | GA | A | 2 |
| 11 | 4 | MCQ | MN | C | 1 |
| 12 | 4 | MCQ | MN | D | 1 |
| 13 | 4 | MCQ | MN | A | 1 |
| 14 | 4 | MCQ | MN | C | 1 |
| 15 | 4 | MCQ | MN | C | 1 |
| 16 | 4 | MCQ | MN | B | 1 |
| 17 | 4 | MCQ | MN | D | 1 |
| 18 | 4 | MCQ | MN | D | 1 |
| 19 | 4 | MCQ | MN | B | 1 |
| 20 | 4 | MCQ | MN | B | 1 |
| 21 | 4 | MCQ | MN | D | 1 |
| 22 | 4 | MCQ | MN | B | 1 |
| 23 | 4 | MCQ | MN | B | 1 |
| 24 | 4 | MCQ | MN | D | 1 |
| 25 | 4 | MCQ | MN | A | 1 |
| 26 | 4 | MCQ | MN | A | 1 |
| 27 | 4 | NAT | MN | 1.40 to 1.45 | 1 |
| 28 | 4 | NAT | MN | 85.00 to 86.00 | 1 |
| 29 | 4 | NAT | MN | 8.10 to 8.20 | 1 |
| 30 | 4 | NAT | MN | 93.00 to 94.00 | 1 |

| | | | | | |
|----|---|-----|----|--------------------|---|
| 31 | 4 | NAT | MN | 0.60 to 0.60 | 1 |
| 32 | 4 | NAT | MN | 13.00 to 14.00 | 1 |
| 33 | 4 | NAT | MN | 85.00 to 87.00 | 1 |
| 34 | 4 | NAT | MN | 0.99 to 0.99 | 1 |
| 35 | 4 | NAT | MN | 22.97 to 23.00 | 1 |
| 36 | 4 | MCQ | MN | A | 2 |
| 37 | 4 | MCQ | MN | B | 2 |
| 38 | 4 | MCQ | MN | B | 2 |
| 39 | 4 | MCQ | MN | C | 2 |
| 40 | 4 | MCQ | MN | A | 2 |
| 41 | 4 | MCQ | MN | A | 2 |
| 42 | 4 | MCQ | MN | D | 2 |
| 43 | 4 | MCQ | MN | C | 2 |
| 44 | 4 | NAT | MN | 0.50 to 0.60 | 2 |
| 45 | 4 | NAT | MN | 0.42 to 0.52 | 2 |
| 46 | 4 | NAT | MN | 0.70 to 0.72 | 2 |
| 47 | 4 | NAT | MN | 3.20 to 3.40 | 2 |
| 48 | 4 | NAT | MN | 89.00 to 91.00 | 2 |
| 49 | 4 | NAT | MN | 15.50 to 16.50 | 2 |
| 50 | 4 | NAT | MN | 16.70 to 17.70 | 2 |
| 51 | 4 | NAT | MN | 1.31 to 1.33 | 2 |
| 52 | 4 | NAT | MN | 0.25 to 0.50 | 2 |
| 53 | 4 | NAT | MN | 0.18 to 0.20 | 2 |
| 54 | 4 | NAT | MN | 19.00 to 20.00 | 2 |
| 55 | 4 | NAT | MN | 6.00 to 7.00 | 2 |
| 56 | 4 | NAT | MN | 2600.00 to 2650.00 | 2 |
| 57 | 4 | NAT | MN | 7.60 to 7.70 | 2 |
| 58 | 4 | NAT | MN | 9.50 to 10.00 | 2 |
| 59 | 4 | NAT | MN | 68.00 to 71.00 | 2 |
| 60 | 4 | NAT | MN | 20.27 to 20.27 | 2 |
| 61 | 4 | NAT | MN | 37.50 to 38.50 | 2 |
| 62 | 4 | NAT | MN | 570.00 to 590.00 | 2 |
| 63 | 4 | NAT | MN | 313.00 to 316.00 | 2 |
| 64 | 4 | NAT | MN | 150.00 to 160.00 | 2 |
| 65 | 4 | NAT | MN | 20.80 to 21.90 | 2 |