

General Aptitude (GA)

Q.1 – Q.5 Carry ONE mark Each

Q.1 If '→' denotes increasing order of intensity, then the meaning of the words [drizzle → rain → downpour] is analogous to [_____ → quarrel → feud]. Which one of the given options is appropriate to fill the blank?

- (A) bicker
- (B) bog
- (C) dither
- (D) dodge

GATE 2024

Q.2 Statements:

1. All heroes are winners.
2. All winners are lucky people.

Inferences:

- I. All lucky people are heroes.
- II. Some lucky people are heroes.
- III. Some winners are heroes.

Which of the above inferences can be logically deduced from statements 1 and 2?

- (A) Only I and II
- (B) Only II and III
- (C) Only I and III
- (D) Only III

Q.3 A student was supposed to **multiply** a positive real number p with another positive real number q . Instead, the student **divided** p by q . If the percentage error in the student's answer is 80%, the value of q is

(A) 5

(B) $\sqrt{2}$

(C) 2

(D) $\sqrt{5}$

Q.4 If the sum of the first 20 consecutive positive odd numbers is divided by 20^2 , the result is

(A) 1

(B) 20

(C) 2

(D) $1/2$

Q.5 The ratio of the number of girls to boys in class VIII is the same as the ratio of the number of boys to girls in class IX. The total number of students (boys and girls) in classes VIII and IX is 450 and 360, respectively. If the number of girls in classes VIII and IX is the same, then the number of girls in each class is

- (A) 150
- (B) 200
- (C) 250
- (D) 175

GATE 2024

Q.6 – Q.10 Carry TWO marks Each

Q.6 In the given text, the blanks are numbered (i)–(iv). Select the best match for all the blanks.

Yoko Roi stands _____ (i) _____ as an author for standing _____ (ii) _____ as an honorary fellow, after she stood _____ (iii) _____ her writings that stand _____ (iv) _____ the freedom of speech.

- (A) (i) out (ii) down (iii) in (iv) for
- (B) (i) down (ii) out (iii) by (iv) in
- (C) (i) down (ii) out (iii) for (iv) in
- (D) (i) out (ii) down (iii) by (iv) for

- Q.7 Seven identical cylindrical chalk-sticks are fitted tightly in a cylindrical container. The figure below shows the arrangement of the chalk-sticks inside the cylinder.

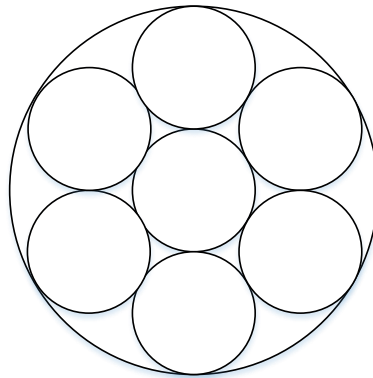

The length of the container is equal to the length of the chalk-sticks. The ratio of the occupied space to the empty space of the container is

- (A) $5/2$
(B) $7/2$
(C) $9/2$
(D) 3

- Q.8 The plot below shows the relationship between the mortality risk of cardiovascular disease and the number of steps a person walks per day. Based on the data, which one of the following options is true?

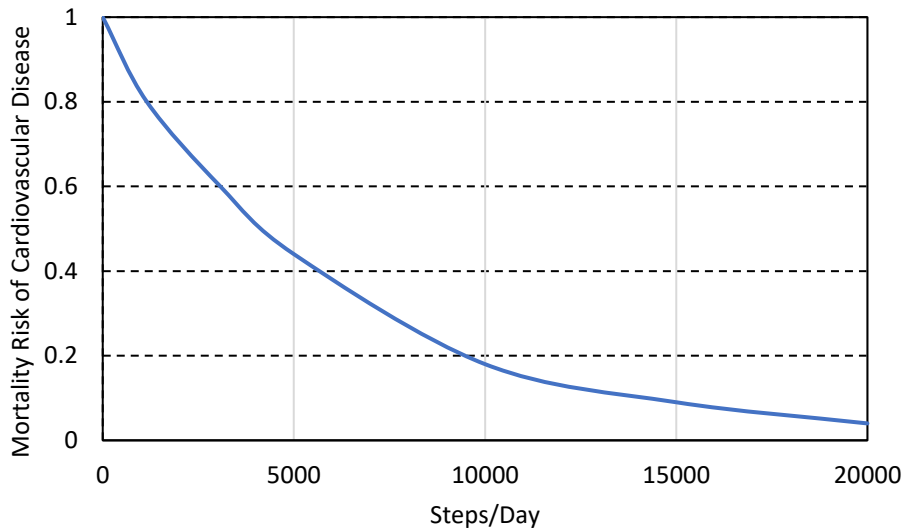

- (A) The risk reduction on increasing the steps/day from 0 to 10000 is less than the risk reduction on increasing the steps/day from 10000 to 20000.
- (B) The risk reduction on increasing the steps/day from 0 to 5000 is less than the risk reduction on increasing the steps/day from 15000 to 20000.
- (C) For any 5000 increment in steps/day the largest risk reduction occurs on going from 0 to 5000.
- (D) For any 5000 increment in steps/day the largest risk reduction occurs on going from 15000 to 20000.

Q.9 Five cubes of identical size and another smaller cube are assembled as shown in Figure A. If viewed from direction X, the planar image of the assembly appears as Figure B.

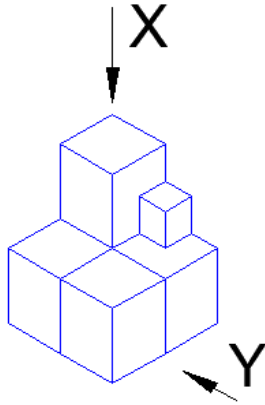

Figure A

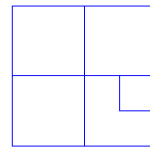
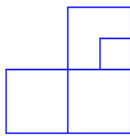

Figure B

If viewed from direction Y, the planar image of the assembly (Figure A) will appear as

(A)



(B)

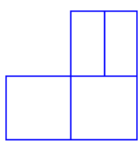

(C)

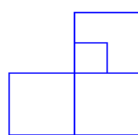

(D)

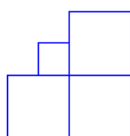

Q.10 Visualize a cube that is held with one of the four body diagonals aligned to the vertical axis. Rotate the cube about this axis such that its view remains unchanged. The magnitude of the minimum angle of rotation is

- (A) 120°
- (B) 60°
- (C) 90°
- (D) 180°

GATE 2024

Q.11 – Q.35 Carry ONE mark Each

Q.11 A partial differential equation

$$\frac{\partial^2 T}{\partial x^2} + \frac{\partial^2 T}{\partial y^2} = 0$$

is defined for the two-dimensional field $T: T(x, y)$, inside a planar square domain of size $2 \text{ m} \times 2 \text{ m}$. Three boundary edges of the square domain are maintained at value $T = 50$, whereas the fourth boundary edge is maintained at $T = 100$.

The value of T at the center of the domain is

- (A) 50.0
- (B) 62.5
- (C) 75.0
- (D) 87.5

Q.12 The statements P and Q are related to matrices **A** and **B**, which are conformable for both addition and multiplication.

P: $(\mathbf{A} + \mathbf{B})^T = \mathbf{A}^T + \mathbf{B}^T$

Q: $(\mathbf{AB})^T = \mathbf{A}^T \mathbf{B}^T$

Which one of the following options is CORRECT?

- (A) P is TRUE and Q is FALSE
- (B) Both P and Q are TRUE
- (C) P is FALSE and Q is TRUE
- (D) Both P and Q are FALSE

GATE 2024

Q.13 The second derivative of a function f is computed using the fourth-order Central Divided Difference method with a step length h .

The CORRECT expression for the second derivative is

(A) $\frac{1}{12h^2} [-f_{i+2} + 16 f_{i+1} - 30 f_i + 16 f_{i-1} - f_{i-2}]$

(B) $\frac{1}{12h^2} [f_{i+2} + 16 f_{i+1} - 30 f_i + 16 f_{i-1} - f_{i-2}]$

(C) $\frac{1}{12h^2} [-f_{i+2} + 16 f_{i+1} - 30 f_i + 16 f_{i-1} + f_{i-2}]$

(D) $\frac{1}{12h^2} [-f_{i+2} - 16 f_{i+1} + 30 f_i - 16 f_{i-1} - f_{i-2}]$

Q.14 The function $f(x) = x^3 - 27x + 4$, $1 \leq x \leq 6$ has

(A) Maxima point

(B) Minima point

(C) Saddle point

(D) Inflection point

Q.15 Consider two Ordinary Differential Equations (ODEs):

$$P: \frac{dy}{dx} = \frac{x^4 + 3x^2y^2 + 2y^4}{x^3y}$$

$$Q: \frac{dy}{dx} = \frac{-y^2}{x^2}$$

Which one of the following options is CORRECT?

- (A) P is a homogeneous ODE and Q is an exact ODE.
- (B) P is a homogeneous ODE and Q is not an exact ODE.
- (C) P is a nonhomogeneous ODE and Q is an exact ODE.
- (D) P is a nonhomogeneous ODE and Q is not an exact ODE.

- Q.16 A 3 m long, horizontal, rigid, uniform beam PQ has negligible mass. The beam is subjected to a 3 kN concentrated vertically downward force at 1 m from P, as shown in the figure. The beam is resting on vertical linear springs at the ends P and Q. For the spring at the end P, the spring constant $K_P = 100$ kN/m.

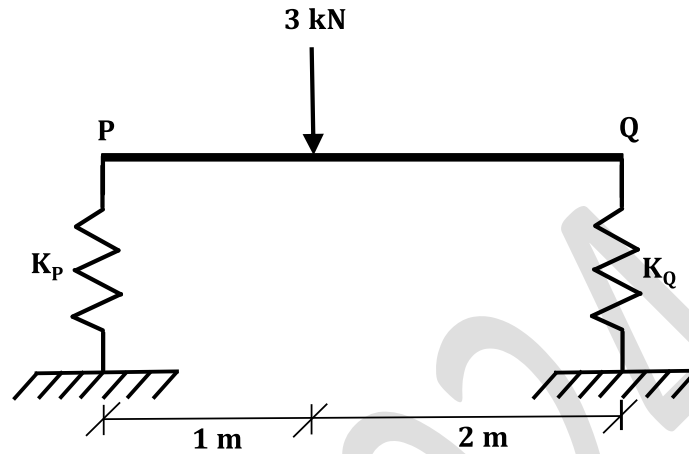

(Figure NOT to scale)

If the beam DOES NOT rotate under the application of the force and displaces only vertically, the value of the spring constant K_Q (in kN/m) for the spring at the end Q is

- (A) 150
- (B) 100
- (C) 50
- (D) 200

Q.17 Consider the statements P and Q.

P: In a Pure project organization, the project manager maintains complete authority and has maximum control over the project.

Q: A Matrix organization structure facilitates quick response to changes, conflicts, and project needs.

Which one of the following options is CORRECT?

- (A) Both P and Q are TRUE
- (B) P is TRUE and Q is FALSE
- (C) Both P and Q are FALSE
- (D) P is FALSE and Q is TRUE

GATE 2024

- Q.18 For a thin-walled section shown in the figure, points P, Q, and R are located on the major bending axis X – X of the section. Point Q is located on the web whereas point S is located at the intersection of the web and the top flange of the section.

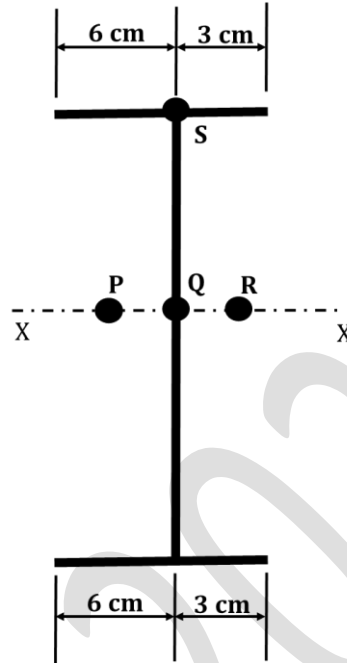

(Figure NOT to scale)

Qualitatively, the shear center of the section lies at

- (A) P
- (B) Q
- (C) R
- (D) S

Q.19 Consider the following data for a project of 300 days duration.

Budgeted Cost of Work Scheduled (BCWS) = Rs. 200

Budgeted Cost of Work Performed (BCWP) = Rs. 150

Actual Cost of Work Performed (ACWP) = Rs. 190

The 'schedule variance' for the project is

- (A) (-)Rs. 50
- (B) (-)50 days
- (C) (+)Rs. 50
- (D) (+)50 days

Q.20 A simply supported, uniformly loaded, two-way slab panel is torsionally unrestrained. The effective span lengths along the short span (x) and long span (y) directions of the panel are l_x and l_y , respectively. The design moments for the reinforcements along the x and y directions are M_{ux} and M_{uy} , respectively. By using Rankine-Grashoff method, the ratio M_{ux}/M_{uy} is proportional to

- (A) l_x/l_y
- (B) l_y/l_x
- (C) $(l_x/l_y)^2$
- (D) $(l_y/l_x)^2$

Q.21 The structural design method that DOES NOT take into account the safety factors on the design loads is

- (A) working stress method.
- (B) load factor method.
- (C) ultimate load method.
- (D) limit state method.

GATE 2024

Q.22 The contact pressure distribution shown in the figure belongs to a

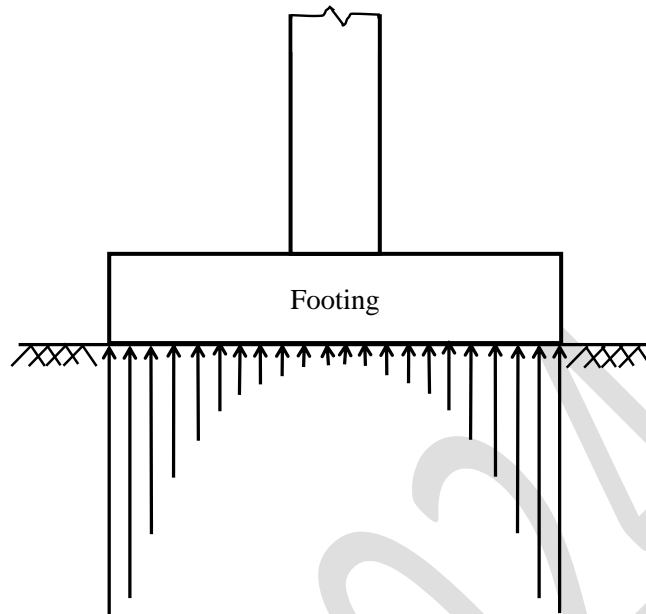

- (A) rigid footing resting on a cohesionless soil.
- (B) rigid footing resting on a cohesive soil.
- (C) flexible footing resting on a cohesionless soil.
- (D) flexible footing resting on a cohesive soil.

Q.23 Which one of the following saturated fine-grained soils can attain a negative Skempton's pore pressure coefficient (A)?

- (A) Quick clays
- (B) Normally-consolidated clays
- (C) Lightly-consolidated clays
- (D) Over-consolidated clays

GATE 2024

Q.24 The following figure shows a plot between shear stress and velocity gradient for materials/fluids P, Q, R, S, and T.

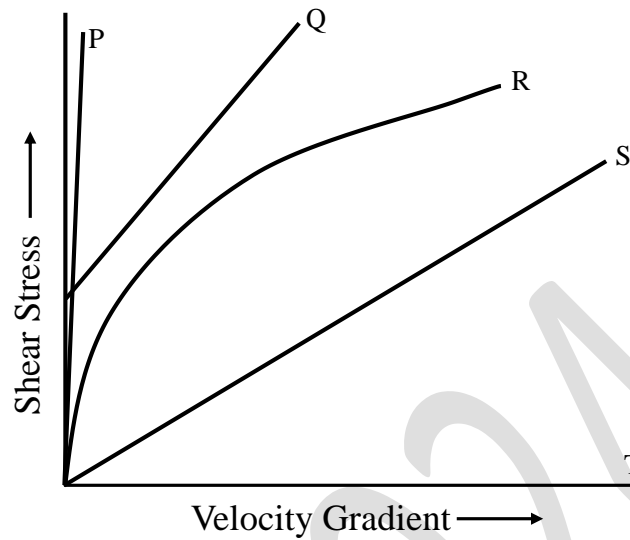

Which one of the following options is CORRECT?

- (A) P → Ideal Fluid; Q → Ideal Bingham plastic
R → Non-Newtonian fluid; S → Newtonian fluid
- (B) P → Real solid; Q → Ideal Bingham plastic
S → Newtonian fluid; T → Ideal Fluid
- (C) P → Ideal Fluid; Q → Ideal Bingham plastic
R → Non-Newtonian fluid; T → Real solid
- (D) P → Real solid; Q → Newtonian fluid
R → Ideal Bingham plastic; T → Ideal Fluid

Q.25 What is the CORRECT match between the air pollutants and treatment techniques given in the table?

Air pollutants	Treatment techniques
P - NO ₂	i - Flaring
Q - SO ₂	ii - Cyclonic separator
R - CO	iii - Lime scrubbing
S - Particles	iv - NH ₃ injection

- (A) P-i, Q-ii, R-iii, S-iv
- (B) P-ii, Q-i, R-iv, S-iii
- (C) P-ii, Q-iii, R-iv, S-i
- (D) P-iv, Q-iii, R-i, S-ii

Q.26 Which one of the following products is NOT obtained in anaerobic decomposition of glucose?

(A) CO_2

(B) CH_4

(C) H_2S

(D) H_2O

GATE 2024

Q.27 The longitudinal sections of a runway have gradients as shown in the table.

End to end for sections of runway (m)	Gradient (%)
0 to 200	+1.0
200 to 600	-1.0
600 to 1200	+0.8
1200 to 1600	+0.2
1600 to 2000	-0.5

Consider the reduced level (RL) at the starting point of the runway as 100 m.

The effective gradient of the runway is

- (A) 0.02%
- (B) 0.35%
- (C) 0.28%
- (D) 0.18%

Q.28 In general, the outer edge is raised above the inner edge in horizontal curves for

- (A) Highways, Railways, and Taxiways
- (B) Highways and Railways only
- (C) Railways and Taxiways only
- (D) Highways only

Q.29 Various stresses in jointed plain concrete pavement with slab size of $3.5 \text{ m} \times 4.5 \text{ m}$ are denoted as follows:

$$\text{Wheel load stress at interior} = S_{wl}^i$$

$$\text{Wheel load stress at edge} = S_{wl}^e$$

$$\text{Wheel load stress at corner} = S_{wl}^c$$

$$\text{Warping stress at interior} = S_t^i$$

$$\text{Warping stress at edge} = S_t^e$$

$$\text{Warping stress at corner} = S_t^c$$

$$\text{Frictional stress between slab and supporting layer} = S_f$$

The critical stress combination in the concrete slab during a summer midnight is

- (A) $S_{wl}^c + S_t^c$
- (B) $S_{wl}^e + S_t^e + S_f$
- (C) $S_{wl}^e + S_t^e - S_f$
- (D) $S_{wl}^c + S_t^c + S_f$

Q.30 For a reconnaissance survey, it is necessary to obtain vertical aerial photographs of a terrain at an average scale of 1: 13000 using a camera. If the permissible flying height is assumed as 3000 m above a datum and the average terrain elevation is 1050 m above the datum, the required focal length (in mm) of the camera is

- (A) 100
- (B) 150
- (C) 125
- (D) 200

Q.31 What is the CORRECT match between the survey instruments/parts of instruments shown in the table and the operations carried out with them?

Instruments/Parts of instruments	Operations
P - Bubble tube	i - Tacheometry
Q - Plumb bob	ii - Minor movements
R - Tangent screw	iii - Centering
S - Stadia cross-wire	iv - Levelling

- (A) P-ii, Q-iii, R-iv, S-i
- (B) P-iv, Q-iii, R-ii, S-i
- (C) P-i, Q-iii, R-ii, S-iv
- (D) P-iii, Q-iv, R-i, S-ii

Q.32 To finalize the direction of a survey, four surveyors set up a theodolite at a station P and performed all the temporary adjustments. From the station P, each of the surveyors observed the bearing to a tower located at station Q with the same instrument without shifting it. The bearings observed by the surveyors are $30^\circ 30' 00''$, $30^\circ 29' 40''$, $30^\circ 30' 20''$ and $30^\circ 31' 20''$. Assuming that each measurement is taken with equal precision, the most probable value of the bearing is

- (A) $30^\circ 29' 40''$
- (B) $30^\circ 30' 20''$
- (C) $30^\circ 30' 00''$
- (D) $30^\circ 31' 20''$

Q.33 The steel angle section shown in the figure has elastic section modulus of 150.92 cm^3 about the horizontal X – X axis, which passes through the centroid of the section.

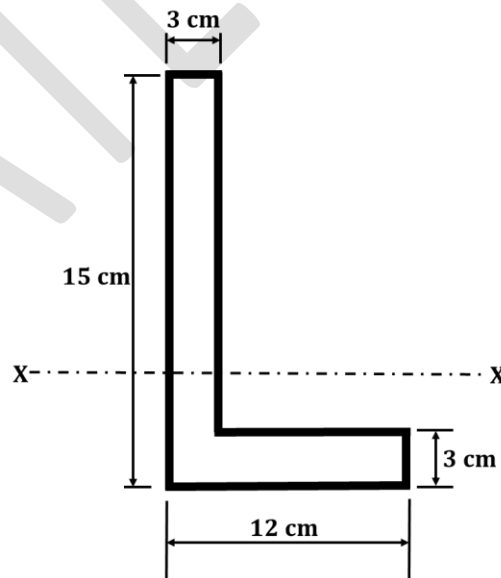

(Figure NOT to scale)

The shape factor of the section is _____ (rounded off to 2 decimal places).

- Q.34 A reinforced concrete pile of 10 m length and 0.7 m diameter is embedded in a saturated pure clay with unit cohesion of 50 kPa. If the adhesion factor is 0.5, the net ultimate uplift pullout capacity (in kN) of the pile is _____ (rounded off to the nearest integer).
- Q.35 A 2 m wide rectangular channel is carrying a discharge of $30 \text{ m}^3/\text{s}$ at a bed slope of 1 in 300. Assuming the energy correction factor as 1.1 and acceleration due to gravity as 10 m/s^2 , the critical depth of flow (in meters) is _____ (rounded off to 2 decimal places).

GATE 2024

Q.36 – Q.65 Carry TWO marks Each

Q.36 In a sample of 100 heart patients, each patient has 80% chance of having a heart attack without medicine X. It is clinically known that medicine X reduces the probability of having a heart attack by 50%. Medicine X is taken by 50 of these 100 patients. The probability that a randomly selected patient, out of the 100 patients, takes medicine X and has a heart attack is

- (A) 40%
- (B) 60%
- (C) 20%
- (D) 30%

GATE 2024

- Q.37 A linearly elastic beam of length $2l$ with flexural rigidity EI has negligible mass. A massless spring with a spring constant k and a rigid block of mass m are attached to the beam as shown in the figure.

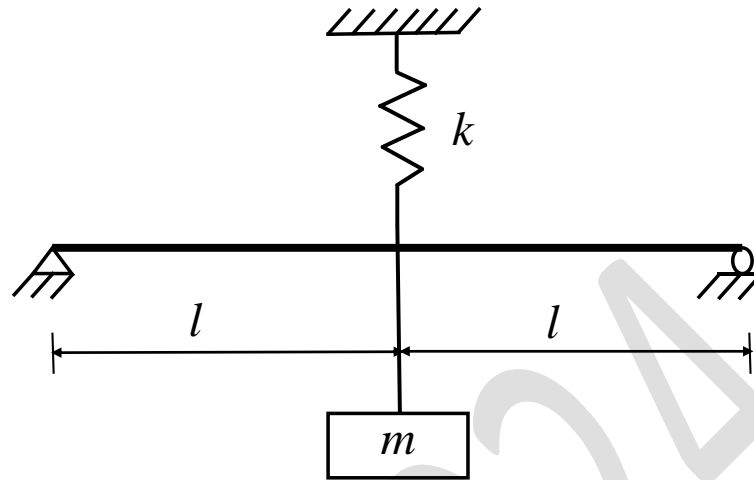

The natural frequency of this system is

- (A) $\sqrt{\frac{kl^3 + 6EI}{ml^3}}$
- (B) $\sqrt{\frac{kl^3 + 48EI}{ml^3}}$
- (C) $\sqrt{\frac{6EIk}{(kl^3 + 6EI)m}}$
- (D) $\sqrt{\frac{48EIk}{(kl^3 + 48EI)m}}$

Q.38 A critical activity in a project is estimated to take 15 days to complete at a cost of Rs. 30,000. The activity can be expedited to complete in 12 days by spending a total amount of Rs. 54,000. Consider the statements P and Q.

P: It is economically advisable to complete the activity early by crashing, if the indirect cost of the project is Rs. 8,500 per day.

Q: It is economically advisable to complete the activity early by crashing, if the indirect cost of the project is Rs. 10,000 per day.

Which one of the following options is CORRECT?

- (A) Both P and Q are TRUE
- (B) P is TRUE and Q is FALSE
- (C) Both P and Q are FALSE
- (D) P is FALSE and Q is TRUE

Q.39 A homogeneous, prismatic, linearly elastic steel bar fixed at both the ends has a slenderness ratio (l/r) of 105, where l is the bar length and r is the radius of gyration. The coefficient of thermal expansion of steel is $12 \times 10^{-6} / ^\circ\text{C}$. Consider the effective length of the steel bar as $0.5l$ and neglect the self-weight of the bar.

The differential increase in temperature (*rounded off to the nearest integer*) at which the bar buckles is

- (A) 298 °C
- (B) 85 °C
- (C) 400 °C
- (D) 250 °C

Q.40 Consider the statements P and Q related to the analysis/design of retaining walls.

P: When a rough retaining wall moves toward the backfill, the wall friction force/resistance mobilizes in upward direction along the wall.

Q: Most of the earth pressure theories calculate the earth pressure due to surcharge by neglecting the actual distribution of stresses due to surcharge.

Which one of the following options is CORRECT?

- (A) Both P and Q are TRUE
- (B) P is TRUE and Q is FALSE
- (C) Both P and Q are FALSE
- (D) P is FALSE and Q is TRUE

Q.41 A round-bottom triangular lined canal is to be laid at a slope of 1 in 1500, to carry a discharge of $25 \text{ m}^3/\text{s}$. The side slopes of the canal cross-section are to be kept at 1.25H : 1V. If Manning's roughness coefficient is 0.013, the flow depth (in meters) will be in the range of

- (A) 2.39 to 2.42
- (B) 1.94 to 1.97
- (C) 2.24 to 2.27
- (D) 2.61 to 2.64

Q.42 A hypothetical multimedia filter, consisting of anthracite particles (specific gravity: 1.50), silica sand (specific gravity: 2.60), and ilmenite sand (specific gravity: 4.20), is to be designed for treating water/wastewater. After backwashing, the particles should settle forming three layers: coarse anthracite particles at the top of the bed, silica sand in the middle, and small ilmenite sand particles at the bottom of the bed.

Assume

- (i) Slow discrete settling (Stoke's law is applicable)
- (ii) All particles are spherical
- (iii) Diameter of silica sand particles is 0.20 mm

The CORRECT option fulfilling the diameter requirements for this filter media is

- (A) diameter of anthracite particles is slightly less than 0.35 mm and diameter of ilmenite particles is slightly greater than 0.141 mm.
- (B) diameter of anthracite particles is slightly greater than 0.35 mm and diameter of ilmenite particles is slightly less than 0.141 mm.
- (C) diameter of anthracite particles is slightly less than 0.64 mm and diameter of ilmenite particles is slightly less than 0.10 mm.
- (D) diameter of anthracite particles is slightly greater than 0.64 mm and diameter of ilmenite particles is slightly less than 0.10 mm.

Q.43 The consolidated data of a spot speed study for a certain stretch of a highway is given in the table.

Speed range (kmph)	Number of observations
0 - 10	7
10 - 20	31
20 - 30	76
30 - 40	129
40 - 50	104
50 - 60	78
60 - 70	29
70 - 80	24
80 - 90	13
90 - 100	9

The “upper speed limit” (in kmph) for the traffic sign is

- (A) 50
- (B) 55
- (C) 65
- (D) 70

Q.44 Three vectors \vec{p} , \vec{q} , and \vec{r} are given as

$$\vec{p} = \hat{i} + \hat{j} + \hat{k}$$

$$\vec{q} = \hat{i} + 2\hat{j} + 3\hat{k}$$

$$\vec{r} = 2\hat{i} + 3\hat{j} + 4\hat{k}$$

Which of the following is/are CORRECT?

(A) $\vec{p} \times (\vec{q} \times \vec{r}) + \vec{q} \times (\vec{r} \times \vec{p}) + \vec{r} \times (\vec{p} \times \vec{q}) = \vec{0}$

(B) $\vec{p} \times (\vec{q} \times \vec{r}) = (\vec{p} \cdot \vec{r}) \vec{q} - (\vec{p} \cdot \vec{q}) \vec{r}$

(C) $\vec{p} \times (\vec{q} \times \vec{r}) = (\vec{p} \times \vec{q}) \times \vec{r}$

(D) $\vec{r} \cdot (\vec{p} \times \vec{q}) = (\vec{q} \times \vec{p}) \cdot \vec{r}$

Q.45 Consider the statements P, Q, and R.

P: Compacted fine-grained soils with flocculated structure have isotropic permeability.

Q: Phreatic surface/line is the line along which the pore water pressure is always maximum.

R: The piping phenomenon occurring below the dam foundation is typically known as blowout piping.

Which of the following option(s) is/are CORRECT?

- (A) Both P and R are TRUE
- (B) P is FALSE and Q is TRUE
- (C) P is TRUE and R is FALSE
- (D) Both Q and R are FALSE

Q.46 In the context of pavement material characterization, the CORRECT statement(s) is/are

- (A) The load penetration curve of CBR test may need origin correction due to the non-vertical penetrating plunger of the loading machine.
- (B) The toughness and hardness of road aggregates are determined by Los Angeles abrasion test and aggregate impact test, respectively.
- (C) Grading of normal (unmodified) bitumen binders is done based on viscosity test results.
- (D) In compacted bituminous mix, Voids in the Mineral Aggregate (VMA) is equal to the sum of total volume of air voids (V_v) and total volume of bitumen (V_b).

- Q.47 The expression for computing the effective interest rate (i_{eff}) using continuous compounding for a nominal interest rate of 5% is

$$i_{eff} = \lim_{m \rightarrow \infty} \left(1 + \frac{0.05}{m}\right)^m - 1$$

The effective interest rate (in percentage) is _____
(rounded off to 2 decimal places).

- Q.48 Consider two matrices $\mathbf{A} = \begin{bmatrix} 2 & 1 & 4 \\ 1 & 0 & 3 \end{bmatrix}$ and $\mathbf{B} = \begin{bmatrix} -1 & 0 \\ 2 & 3 \\ 1 & 4 \end{bmatrix}$.

The determinant of the matrix \mathbf{AB} is _____ (in integer).

- Q.49 For the 6 m long horizontal cantilever beam PQR shown in the figure, Q is the midpoint. Segment PQ of the beam has flexural rigidity $EI = 2 \times 10^5 \text{ kN.m}^2$ whereas the segment QR has infinite flexural rigidity. Segment QR is subjected to uniformly distributed, vertically downward load of 5 kN/m.

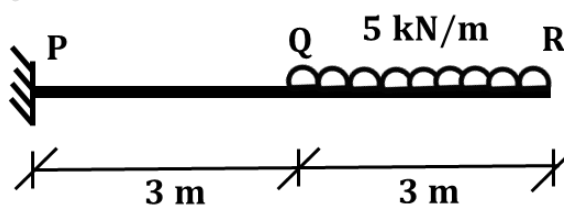

(Figure NOT to scale)

The magnitude of the vertical displacement (in mm) at point Q is _____ (rounded off to 3 decimal places).

Q.50 The horizontal beam PQRS shown in the figure has a fixed support at point P, an internal hinge at point Q, and a pin support at point R. A concentrated vertically downward load (V) of 10 kN can act at any point over the entire length of the beam.

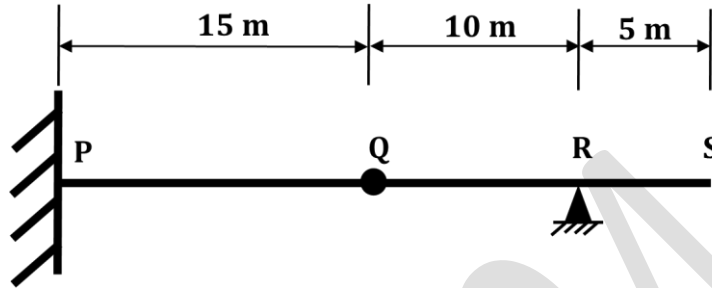

(Figure NOT to scale)

The maximum magnitude of the moment reaction (in kN.m) that can act at the support P due to V is _____ (in integer).

Q.51 A concrete column section of size 300 mm \times 500 mm as shown in the figure is subjected to both axial compression and bending along the major axis. The depth of the neutral axis (x_u) is 1.1 times the depth of the column, as shown.

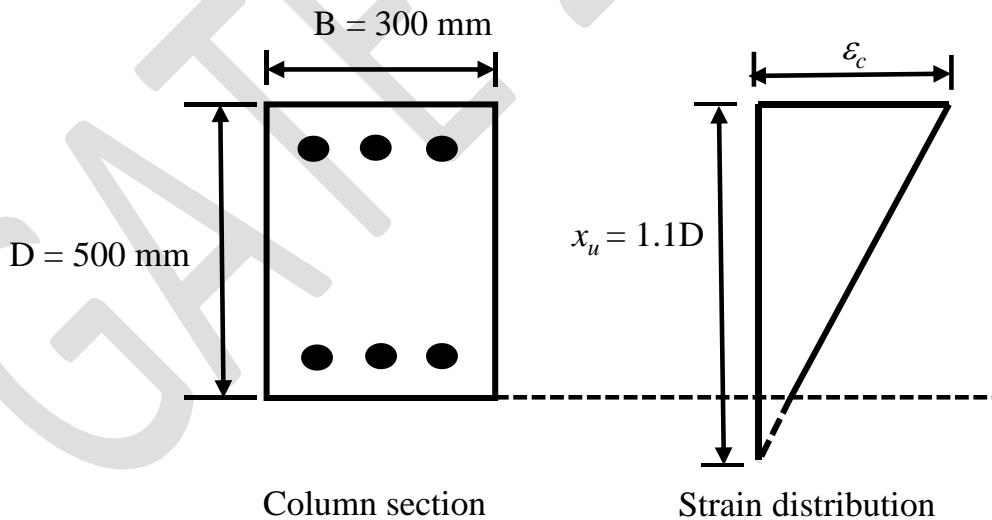

(Figure NOT to scale)

The maximum compressive strain (ϵ_c) at highly compressive extreme fiber in concrete, where there is no tension in the section, is _____ $\times 10^{-3}$ (rounded off to 2 decimal places).

Q.52 The table shows the activities and their durations and dependencies in a project.

Activity	Duration (Days)	Depends on
A	8	-
B	4	A
C	4	B
D	4	C, L
F	4	A
G	4	F
H	6	G, L
K	10	A
L	6	F, K

The total duration (in days) of the project is _____ (in integer).

Q.53 A homogeneous earth dam has a maximum water head difference of 15 m between the upstream and downstream sides. A flownet was drawn with the number of potential drops as 10 and the average length of the element as 3 m. Specific gravity of the soil is 2.65. For a factor of safety of 2.0 against piping failure, void ratio of the soil is _____ (rounded off to 2 decimal places).

Q.54 The in-situ percentage of voids of a sand deposit is 50%. The maximum and minimum densities of sand determined from the laboratory tests are 1.8 g/cm^3 and 1.3 g/cm^3 , respectively. Assume the specific gravity of sand as 2.7.

The relative density index of the in-situ sand is _____ (rounded off to 2 decimal places).

Q.55 A drained triaxial test was conducted on a saturated sand specimen using a stress-path triaxial testing system. The specimen failed when the axial stress reached a value of 100 kN/m^2 from an initial confining pressure of 300 kN/m^2 .

The angle of shearing plane (in degrees) with respect to horizontal is _____ (rounded off to the nearest integer).

- Q.56 A storm with a recorded precipitation of 11.0 cm, as shown in the table, produced a direct run-off of 6.0 cm.

Time from start (hours)	1	2	3	4	5	6	7	8
Recorded cumulative precipitation (cm)	0.5	1.5	3.1	5.5	7.3	8.9	10.2	11.0

The ϕ -index of this storm is _____ cm/hr (rounded off to 2 decimal places).

- Q.57 A 500 m long water distribution pipeline P with diameter 1.0 m, is used to convey $0.1 \text{ m}^3/\text{s}$ of flow. A new pipeline Q, with the same length and flow rate, is to replace P. The friction factors for P and Q are 0.04 and 0.01, respectively. The diameter of the pipeline Q (in meters) is _____ (rounded off to 2 decimal places).

- Q.58 A $2 \text{ m} \times 1.5 \text{ m}$ tank of 6 m height is provided with a 100 mm diameter orifice at the center of its base. The orifice is plugged and the tank is filled up to 5 m height. Consider the average value of discharge coefficient as 0.6 and acceleration due to gravity (g) as 10 m/s^2 . After unplugging the orifice, the time (in seconds) taken for the water level to drop from 5 m to 3.5 m under free discharge condition is _____ (rounded off to 2 decimal places).

- Q.59 A rectangular channel is 4.0 m wide and carries a discharge of $2.0 \text{ m}^3/\text{s}$ with a depth of 0.4 m. The channel transitions to a maximum width contraction at a downstream location, without influencing the upstream flow conditions. The width (in meters) at the maximum contraction is _____ (rounded off to 2 decimal places).

- Q.60 A circular settling tank is to be designed for primary treatment of sewage at a flow rate of 10 million liters/day. Assume a detention period of 2.0 hours and surface loading rate of $40000 \text{ liters/m}^2/\text{day}$. The height (in meters) of the water column in the tank is _____ (rounded off to 2 decimal places).

Q.61 An organic waste is represented as $C_{240}O_{200}H_{180}N_5S$.

(Atomic weights: S-32, H-1, C-12, O-16, N-14).

Assume complete conversion of S to SO_2 while burning.

SO_2 generated (in grams) per kg of this waste is _____
(rounded off to 1 decimal place).

Q.62 A horizontal curve of radius 1080 m (with transition curves on either side) in a Broad Gauge railway track is designed and constructed for an equilibrium speed of 70 kmph. However, a few years after construction, the Railway Authorities decided to run express trains on this track. The maximum allowable cant deficiency is 10 cm.

The maximum restricted speed (in kmph) of the express trains running on this track is _____ (rounded off to the nearest integer).

Q.63 A vertical summit curve on a freight corridor is formed at the intersection of two gradients, +3.0% and -5.0%.

Assume the following:

Only large-sized trucks are allowed on this corridor

Design speed = 80 kmph

Eye height of truck drivers above the road surface = 2.30 m

Height of object above the road surface for which trucks need to stop = 0.35 m

Total reaction time of the truck drivers = 2.0 s

Coefficient of longitudinal friction of the road = 0.36

Stopping sight distance gets compensated on the gradient

The design length of the summit curve (in meters) to accommodate the stopping sight distance is _____ (rounded off to 2 decimal places).

Q.64 A child walks on a level surface from point P to point Q at a bearing of 30° , from point Q to point R at a bearing of 90° and then directly returns to the starting point P at a bearing of 240° . The straight-line paths PQ and QR are 4 m each. Assuming that all bearings are measured from the magnetic north in degrees, the straight-line path length RP (in meters) is _____ (rounded off to the nearest integer).

Q.65 Differential levelling is carried out from point P (BM: +200.000 m) to point R. The readings taken are given in the table.

Points	Staff readings (m)		Remarks
	Back Sight	Fore Sight	
P	(-)2.050		BM: +200.000 m
Q	1.050	0.950	Q is a change point
R		(-)1.655	

Reduced Level (in meters) of the point R is _____ (rounded off to 3 decimal places).

GATE 2024



GRADUATE APTITUDE TEST IN ENGINEERING 2024

अभियांत्रिकी स्नातक अभिक्षमता परीक्षा २०२४

ORGANISING INSTITUTE: INDIAN INSTITUTE OF SCIENCE, BENGALURU



Civil Engineering (CE2) Master Answer Key

Q. No.	Session	Question Type	Section	Key/Range	Mark
1	4	MCQ	GA	A	1
2	4	MCQ	GA	B	1
3	4	MCQ	GA	D	1
4	4	MCQ	GA	A	1
5	4	MCQ	GA	B	1
6	4	MCQ	GA	D	2
7	4	MCQ	GA	B	2
8	4	MCQ	GA	C	2
9	4	MCQ	GA	A	2
10	4	MCQ	GA	A	2
11	4	MCQ	CE-2	B	1
12	4	MCQ	CE-2	A	1
13	4	MCQ	CE-2	A	1
14	4	MCQ	CE-2	B	1
15	4	MCQ	CE-2	B	1
16	4	MCQ	CE-2	C	1
17	4	MCQ	CE-2	A	1
18	4	MCQ	CE-2	C	1
19	4	MCQ	CE-2	A	1
20	4	MCQ	CE-2	D	1
21	4	MCQ	CE-2	A	1
22	4	MCQ	CE-2	B	1
23	4	MCQ	CE-2	D	1
24	4	MCQ	CE-2	B	1
25	4	MCQ	CE-2	D	1
26	4	MCQ	CE-2	C	1
27	4	MCQ	CE-2	C	1
28	4	MCQ	CE-2	B	1
29	4	MCQ	CE-2	A	1

30	4	MCQ	CE-2	B	1
31	4	MCQ	CE-2	B	1
32	4	MCQ	CE-2	B	1
33	4	NAT	CE-2	1.75 to 1.85	1
34	4	NAT	CE-2	545 to 555	1
35	4	NAT	CE-2	2.88 to 2.94	1
36	4	MCQ	CE-2	C	2
37	4	MCQ	CE-2	A	2
38	4	MCQ	CE-2	A	2
39	4	MCQ	CE-2	A	2
40	4	MCQ	CE-2	A	2
41	4	MCQ	CE-2	A	2
42	4	MCQ	CE-2	A	2
43	4	MCQ	CE-2	B	2
44	4	MSQ	CE-2	A;B	2
45	4	MSQ	CE-2	C;D	2
46	4	MSQ	CE-2	A;C;D	2
47	4	NAT	CE-2	5.11 to 5.15	2
48	4	NAT	CE-2	10 to 10	2
49	4	NAT	CE-2	1.176 to 1.186	2
50	4	NAT	CE-2	150 to 150	2
51	4	NAT	CE-2	3.20 to 3.40	2
52	4	NAT	CE-2	30 to 30	2
53	4	NAT	CE-2	0.63 to 0.67	2
54	4	NAT	CE-2	0.12 to 0.14	2
55	4	NAT	CE-2	30 to 30	2
56	4	NAT	CE-2	0.64 to 0.65	2
57	4	NAT	CE-2	0.70 to 0.80	2
58	4	NAT	CE-2	102.00 to 106.00	2
59	4	NAT	CE-2	3.30 to 3.70	2
60	4	NAT	CE-2	3.25 to 3.40	2
61	4	NAT	CE-2	9.9 to 10.2	2
62	4	NAT	CE-2	113 to 116	2
63	4	NAT	CE-2	117.00 to 120.00	2
64	4	NAT	CE-2	6 to 8	2
65	4	NAT	CE-2	199.704 to 199.706	2